

TECHNISCHE FICHE

VIERKANTE SCHARNIERHAAK 8X8 CM

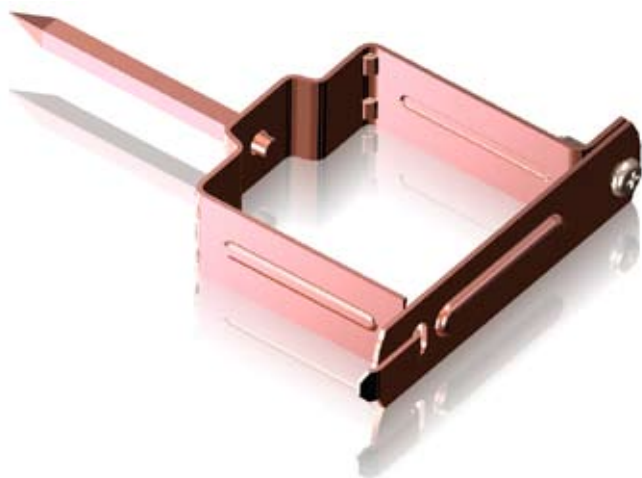

art nr	materiaal	dikte	breedte	pin	afwerking	gewicht	verpakking
SCHV8-ZN	zink (NEN-EN 988)	1.5 mm	30 mm	ja	-	218 g	25 st/doos
SCHV8-ZPZN	zink (NEN-EN 988)	1.5 mm	30 mm	-	-	184 g	25 st/doos
SCHV8-ZZ	zink (NEN-EN 988)	1.5 mm	30 mm	ja	poedercoating RAL 9035 ($\geq 60 \mu\text{m}$)	218 g	25 st/doos
SCHV8-ZPZZ	zink (NEN-EN 988)	1.5 mm	30 mm	-	poedercoating RAL 9035 ($\geq 60 \mu\text{m}$)	184 g	25 st/doos
SCHV8-K	koper (NEN-EN 1172)	1.5 mm	30 mm	ja	-	233 g	25 st/doos
SCHV8-IN	roestvast staal 1.4301	1.5 mm	30 mm	ja	-	224 g	25 st/doos

model met pin:

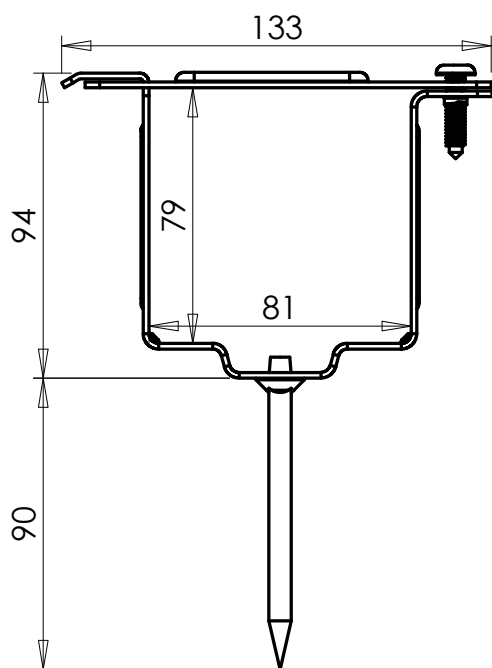

model zonder pin:

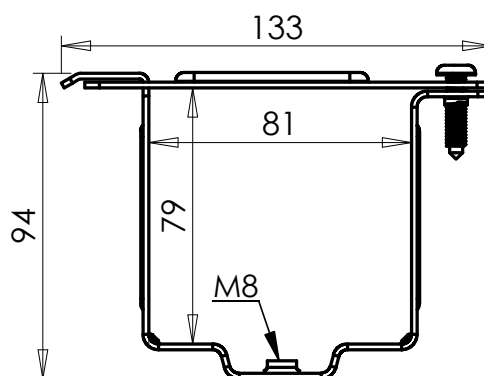

Synoniem van KWALITEIT en SERVICE

APOK KAMPENHOUT
 administratieve hoofdzetel
 Oudestraat 11, B-1910 Kampenhout
 Tel.: +32 (0)16 61 72 62 - Fax: +32(0)16 61 72 81
 Website: www.apok.be - E-mail: info@apok.be

